

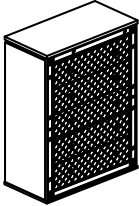





ASSEMBLY INSTRUCTION INSTRUCCIONES

B1680-4 CHEST B1680-4 CAJONERO

PARTS LIST
LISTA DE PARTES

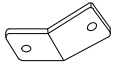
A	CHEST / CAJONERO		1PC / PIEZA
B	LEGS / PIERNA		4PCS / PIEZAS

ANTI-TIPPING HARDWARE LIST
LISTA DE HARDWARE ANTI-TIPPING

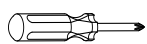
1	BRACKET		2PCS / PIEZAS
2	TIE WRAP		1PC / PIEZA
3	LONG SCREW #8x2" L		1PC / PIEZA
4	SHORT SCREW #8x5/8" L		1PC / PIEZA
ASSEMBLY TOOL NOT INCLUDED			

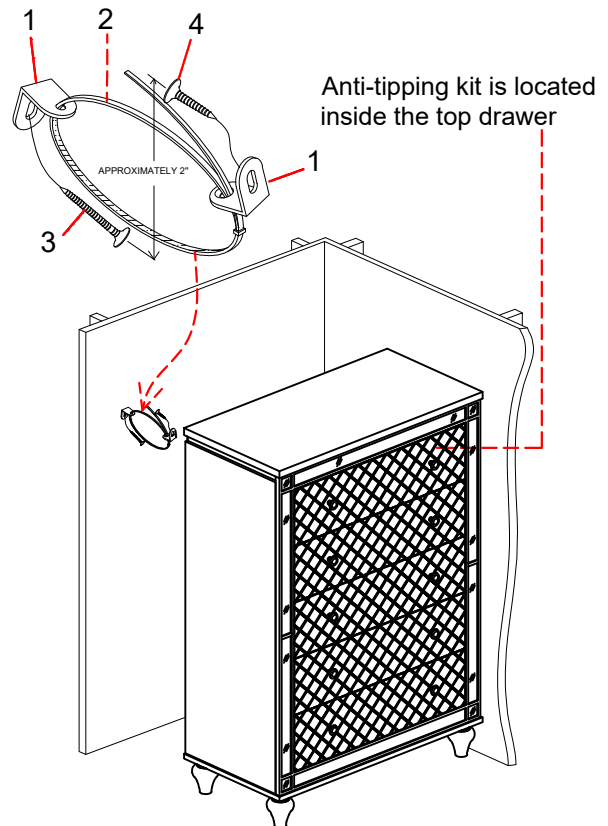
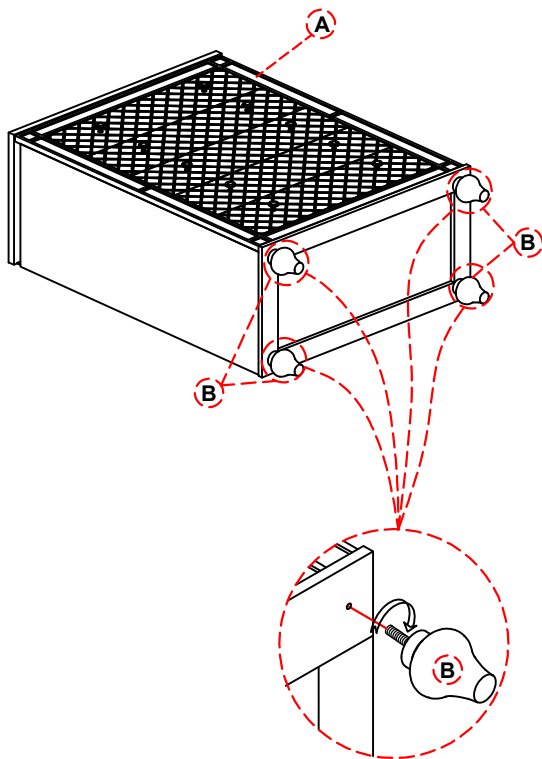

NOTE: Periodically check to ensure that all connectors (bolts, screws, etc.) are tight.

NOTA: Verifique periódicamente que todos los conectores (tuercas, tornillos, etc.) estén bien apretados.