





# ASSEMBLY INSTRUCTIONS

ITEM NO : B2180-1 & 11  
DRESSER & MIRROR

**(BOX 1)  
BOX OF MIRROR**

ITEM	DRAWING	DESCRIPTION	QTY
A		DRESSER TOP	1
B		DRESSER TOP SUPPORT	2

**(BOX 1)  
HARDWARE LIST**

ITEM	DRAWING	DESCRIPTION	QTY
1		SHORT ALLEN KEY	1
2		CONNECTION BOLT (M6 x 40mm) W/WASHER & SPRING WASHER	8

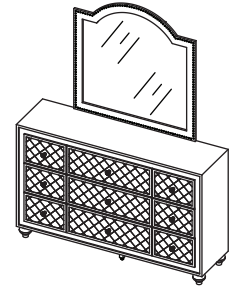

**COMPLETED DRESSER AND  
MIRROR ASSEMBLY**

**(BOX 2)  
BOX OF DRESSER**

ITEM	DRAWING	DESCRIPTION	QTY
A		DRESSER	1

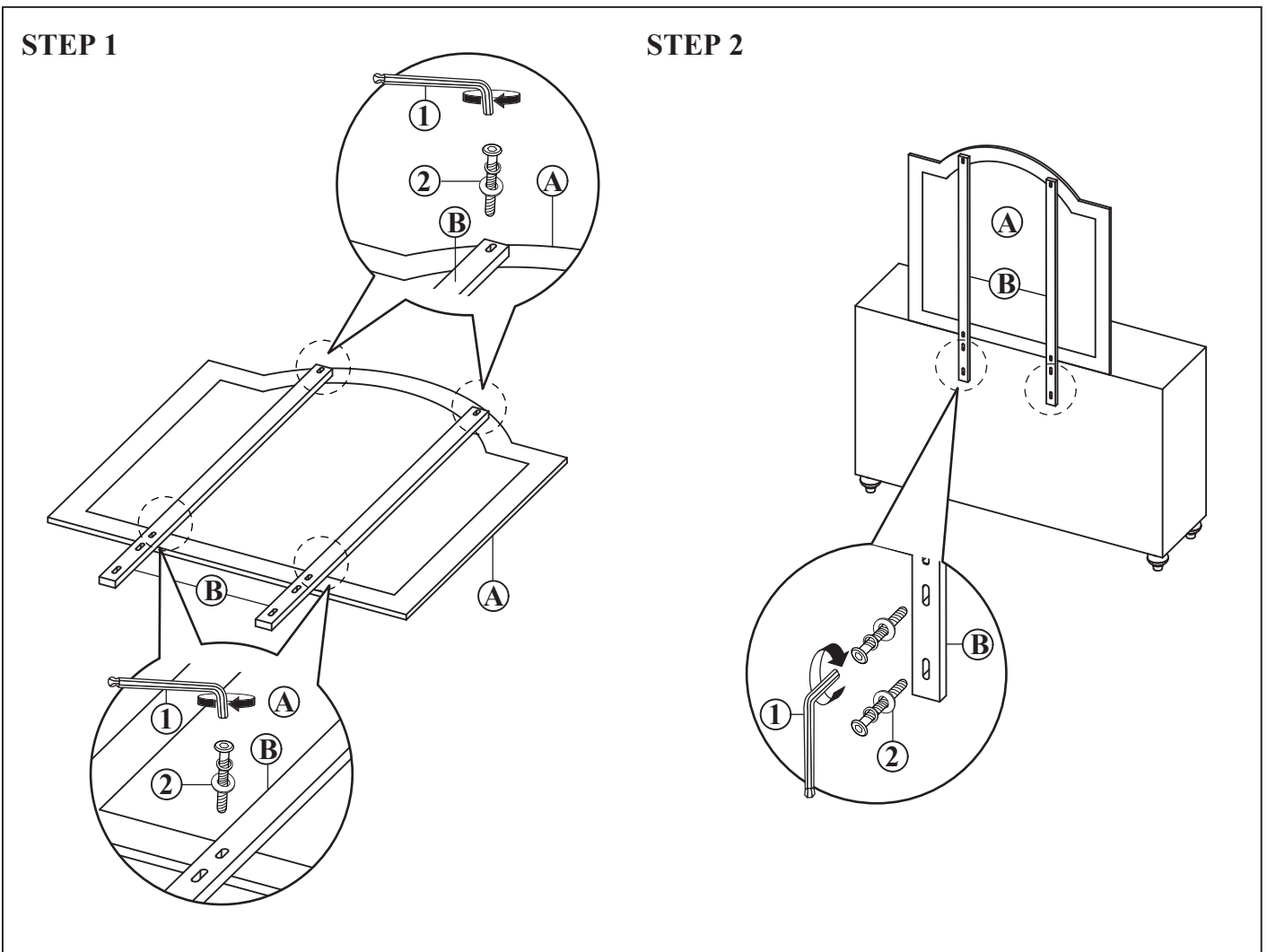

THE HARDWARE IS LOCATED IN THE PACKING ITEMS.  
THE ANTI TIPPING HARDWARE IS LOCATED IN THE TOP RIGHT SIDE FRONT DRAWER OF THE DRESSER.

NOTE : PERIODICALLY CHECK TO ENSURE THAT ALL CONNECTORS (BOLTS, SCREWS, ETC.) ARE TIGHT.

**CLEANING INSTRUCTION**

After assembly, clean & polish the completed parts if necessary with soft cloth and industrial recognized furniture polish

MADE IN MALAYSIA