

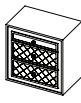





ASSEMBLY INSTRUCTIONS

ITEM NO : B2100-2 / B2180-2
NIGHT STAND

BOX OF NIGHT STAND PART LIST

| ITEM | DRAWING | DESCRIPTION | QTY |
|------|---|--|-----|
| A |  | NIGHT STAND | 1 |
| B |  | BUN FOOT **Is inside the Night Stand Bottom Drawer | 4 |
| C |  | GLASS TOP **Packed in an inner box inside the Night Stand Please handle with care | 1 |

HARDWARE LIST

| TIPPING RESTRAINT (Affix to wall behind Night Stand) *Located in the Top Drawer of Night Stand | | | |
|--|---|------------------|-----|
| ITEM | DRAWING | DESCRIPTION | QTY |
| 1 |  | BRACKET | 2 |
| 2 |  | STRAP | 1 |
| 3 |  | LONG SCREW 50MM | 1 |
| 4 |  | SHORT SCREW 15MM | 1 |

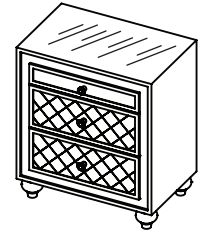

COMPLETED NIGHT STAND ASSEMBLY

NOTE: GLASS TOP HANDLE WITH
CARE "FRAGILE"

STEP 1

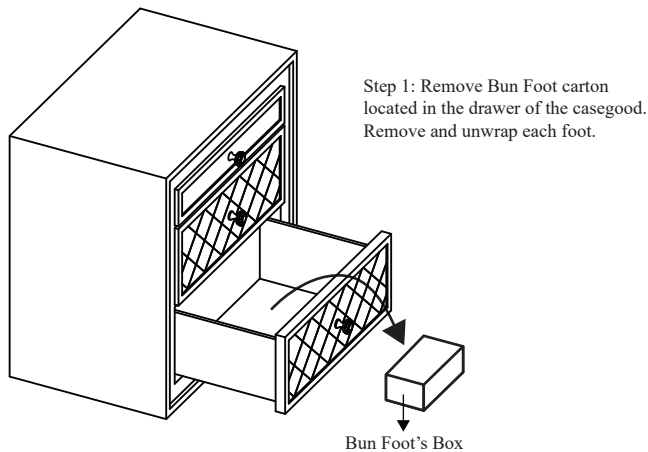

STEP 2

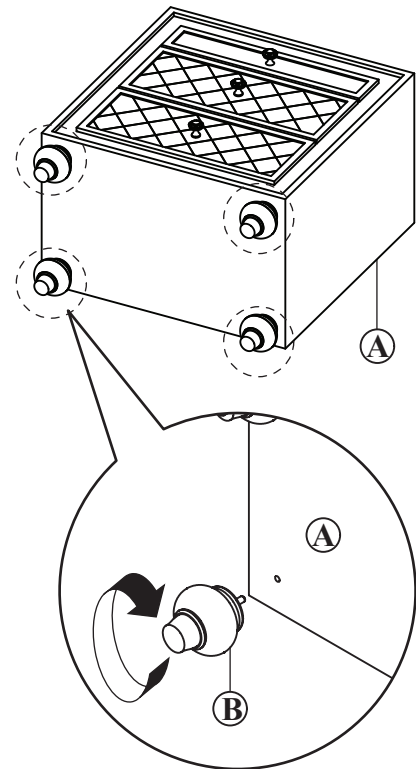

STEP 3

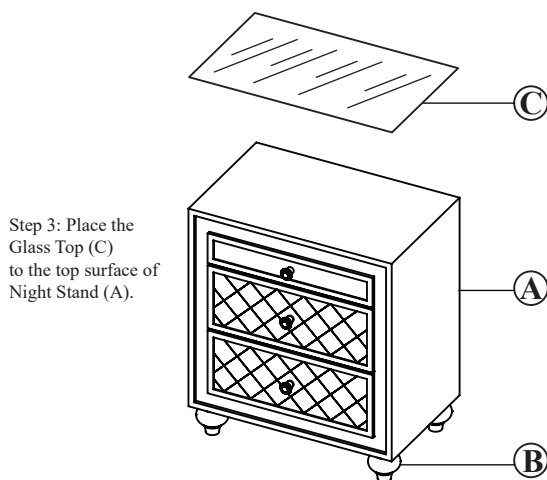

NOTE :
THE GLASS TOP (C) IS PACKED BETWEEN THE 2 PIECES OF POLYFOAM, WITH A "GLASS TOP" STICKER, WHICH IS NOTICEABLE UPON REMOVING THE CARTON BOX.

THE HARDWARE IS LOCATED IN THE PACKING ITEMS.

THE ANTI TIPPING HARDWARE IS LOCATED IN THE TOP DRAWER OF THE NIGHT STAND.

NOTE : PERIODICALLY CHECK TO ENSURE THAT ALL CONNECTORS (BOLTS, SCREWS, ETC.) ARE TIGHT.

CLEANING INSTRUCTION

After assembly, clean & polish the completed parts if necessary with soft cloth and industrial recognized furniture polish

MADE IN MALAYSIA

ANTI-TIPPING INSTALLMENT INSTRUCTIONS

ITEM NO : B2100-2 / B2180-2
NIGHT STAND

WARNING

Injury may result from tipping furniture.
This restraint may protect against tipping furniture.
Do not allow children to climb on furniture.
This restraint is not a substitute for proper adult supervision.
Failure to detach this restraint before moving the furniture may result injury and damage.

STEP 1

This tip restraint must be attached to a wall stud using long screw enclosed.

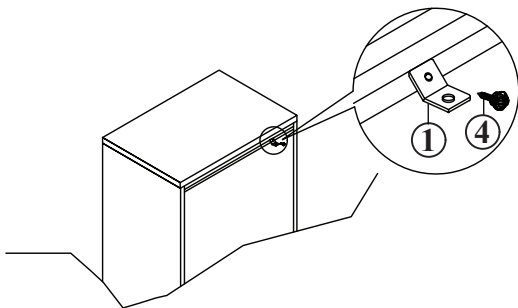

Attach a bracket securely to the back top rail of the furniture using short screw provided, through the smaller hole.

STEP 2

Locate the other bracket on the wall over a wall stud and two inches below the mounting bracket secured to the back of the furniture. Attach the wall stud using the long screw provided, through the smaller hole.

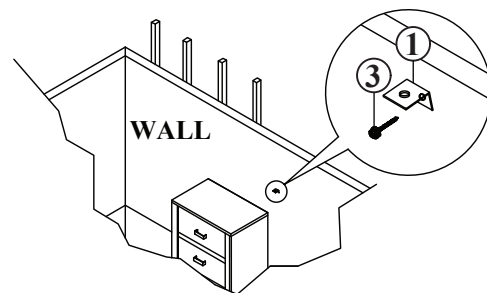

STEP 3

Place the furniture into position so both mounting brackets are vertically in line. Lace the end of the restraint strap through the larger hole in each mounting bracket. Bring both ends together and slide the flat end through the locking end and draw it through until all slack is removed.

Confirm that the strap is securely laced and locked.

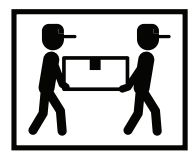
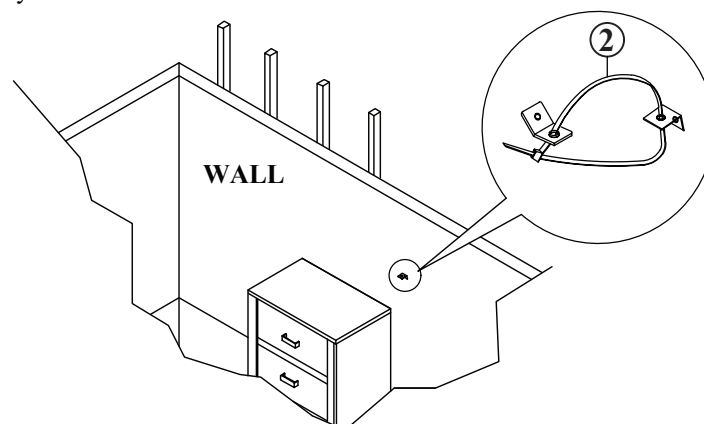

THE HARDWARE IS LOCATED IN THE PACKING ITEMS.
THE ANTI TIPPING HARDWARE IS LOCATED IN THE TOP DRAWER OF THE NIGHT STAND.

NOTE : PERIODICALLY CHECK TO ENSURE THAT ALL CONNECTORS (BOLTS, SCREWS, ETC.) ARE TIGHT.

CLEANING INSTRUCTION

After assembly, clean & polish the completed parts if necessary with soft cloth and industrial recognized furniture polish

MADE IN MALAYSIA