











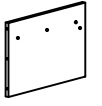

ASSEMBLY INSTRUCTIONS

ITEM NO : B3400-2
TILSTON NIGHT STAND W/BACK PANEL





BOX OF NIGHT STAND

ITEM	DRAWING	DESCRIPTION	QTY
A		NIGHT STAND	1
B		LEG (Packed underneath bottom panel)	4
C		BACK PANEL	1
D		CENTER PANEL	1
E		SIDE PANEL (LEFT & RIGHT)	2
F		BACK SUPPORT	2



BOX OF NIGHT STAND HARDWARE LIST FOR THE NIGHT STAND LEG (INSIDE LEG BOX)

ITEM	DRAWING	DESCRIPTION	QTY
1		JCBC BOLT WITH SPRING WASHER AND FLAT WASHER (M6 x 60mm)	8
2		ALLEN KEY (M4)	1
3		TIPPING RESTRAINT (Affix to wall behind Night Stand) * Located in the Night Stand 1st Drawer	
		BRACKET	2
		TIE WRAP	1
		LONG SCREW #8x2" L	1
		SHORT SCREW #8x5/8" L	1

HARDWARE LIST FOR THE NIGHT STAND BACK PANEL (INSIDE BACK PANEL BOX)

ITEM	DRAWING	DESCRIPTION	QTY
4		JCBC BOLT WITH SPRING WASHER AND FLAT WASHER (M6 x 40mm)	11
5		FITTING SYSTEM 5 (05656.885 + 05137.880)	6
6		METAL PLATE (68 x 19 x 2mm)	2
7		JCBC BOLT WITH SPRING WASHER AND FLAT WASHER (M6 x 16mm)	4
8		ALLEN KEY (M4)	1

TO ATTACHED THE NIGHT STAND TO THE BED
(BECOME A WALL BED)
QUEEN BED (H) OR KING BED (I)

ITEM	DRAWING	DESCRIPTION	QTY
H		QUEEN BED	1
OR			
I		KING BED	1

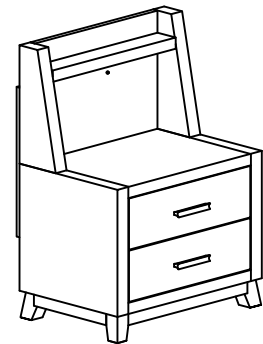

**COMPLETED NIGHT STAND
W/BACK PANEL ASSEMBLY**

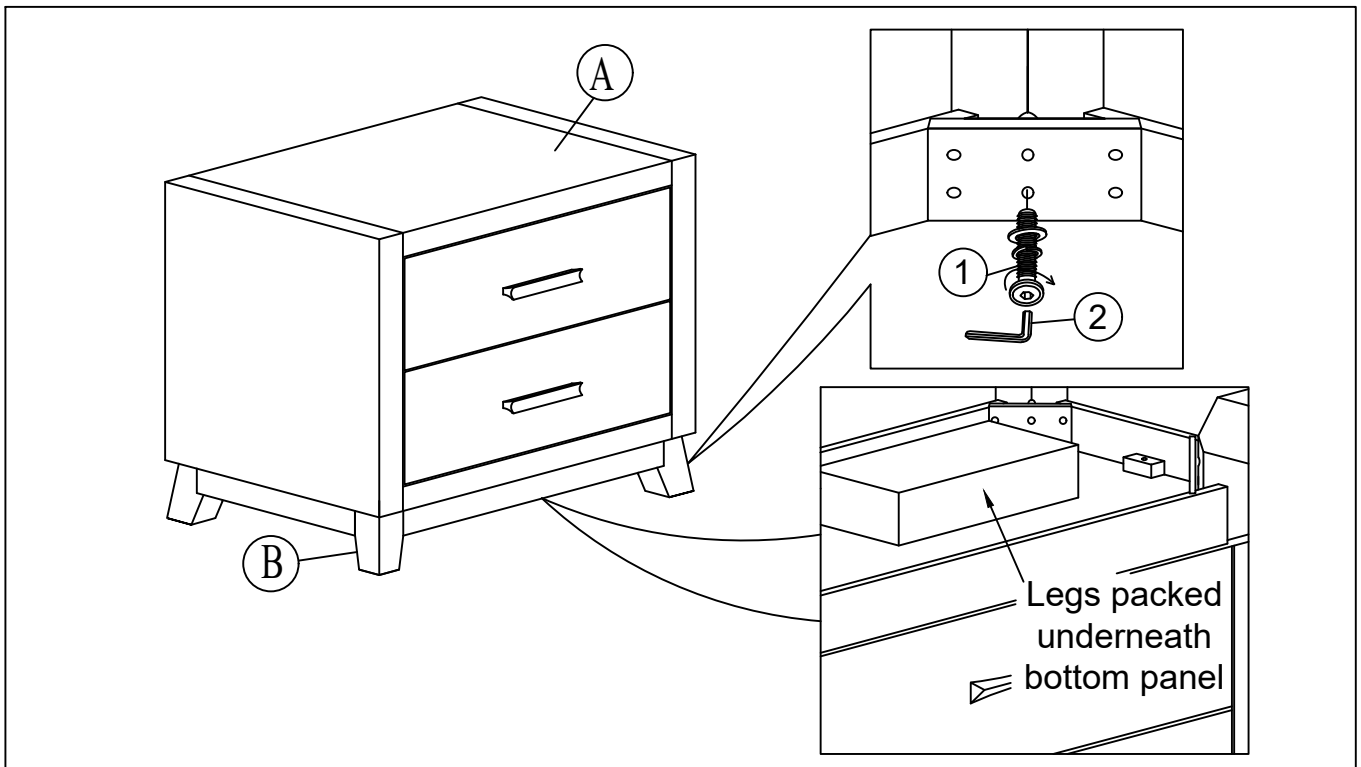

THE HARDWARE IS LOCATED IN THE PACKING ITEMS
THE ANTI TIPPING HARDWARE IS LOCATED IN THE NIGHTSTAND 1ST DRAWER

NOTE : Periodically check to ensure that all connectors (bolts, screws, etc.) are tight.

CLEANING INSTRUCTION

After assembled, clean & polish the completed parts if necessary with soft cloth and industrial recognized furniture polish

MADE IN MALAYSIA

ASSEMBLY INSTRUCTIONS

ITEM NO : B3400-2
TILSTON NIGHTSTAND W/BACK PANEL

STEP 1:

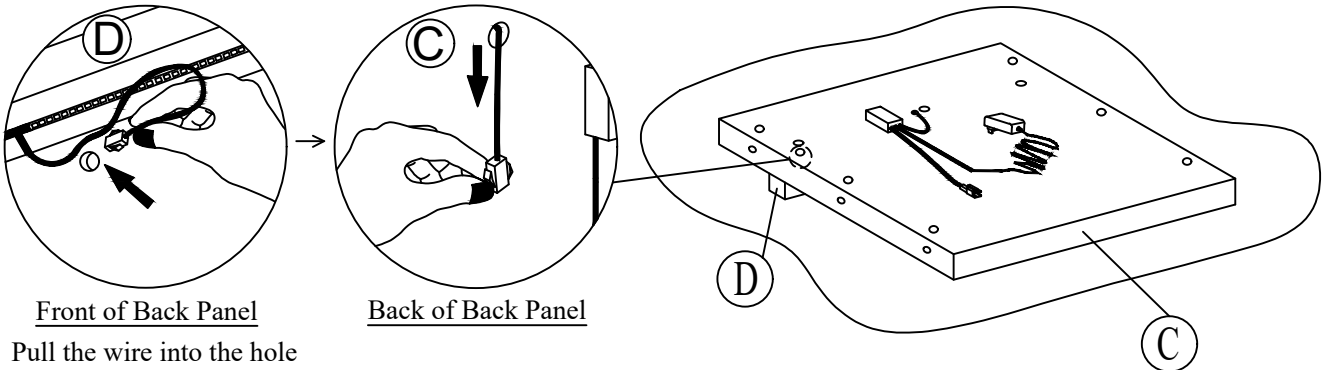

STEP 2:

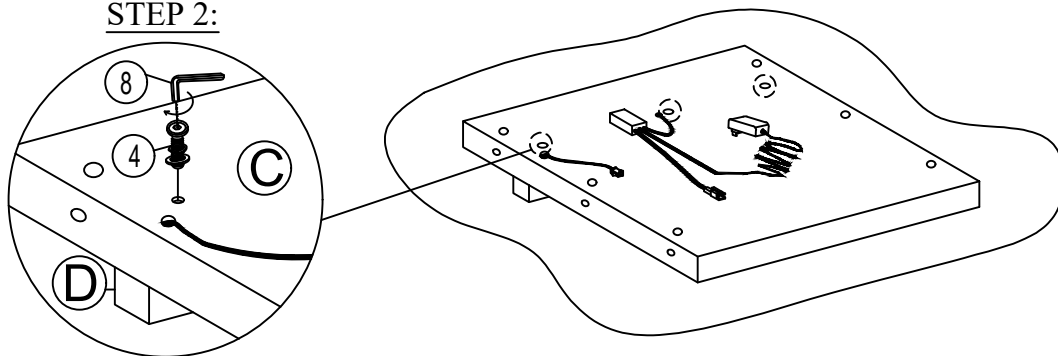

STEP 3:

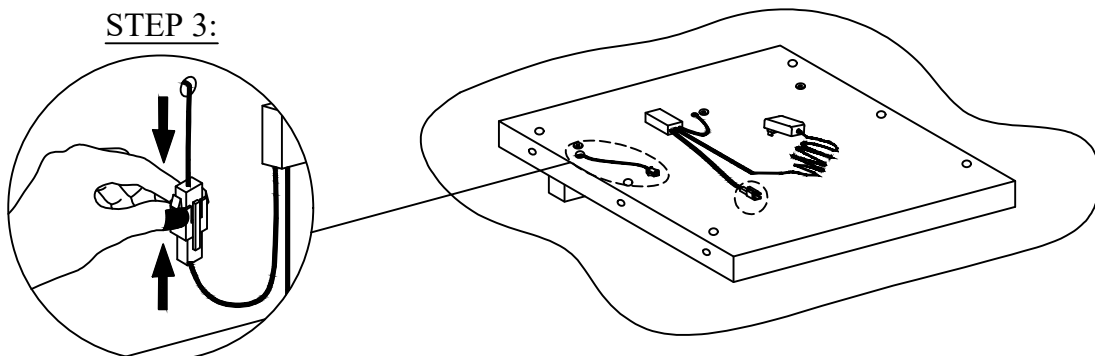

THE HARDWARE IS LOCATED IN THE PACKING ITEMS
THE ANTI TIPPING HARDWARE IS LOCATED IN THE NIGHTSTAND 1ST DRAWER

NOTE : Periodically check to ensure that all connectors (bolts, screws, etc.) are tight.

CLEANING INSTRUCTION

After assembled, clean & polish the completed parts if necessary with soft cloth and industrial recognized furniture polish

MADE IN MALAYSIA

ASSEMBLY INSTRUCTIONS

ITEM NO : B3400-2
TILSTON NIGHTSTAND W/BACK PANEL

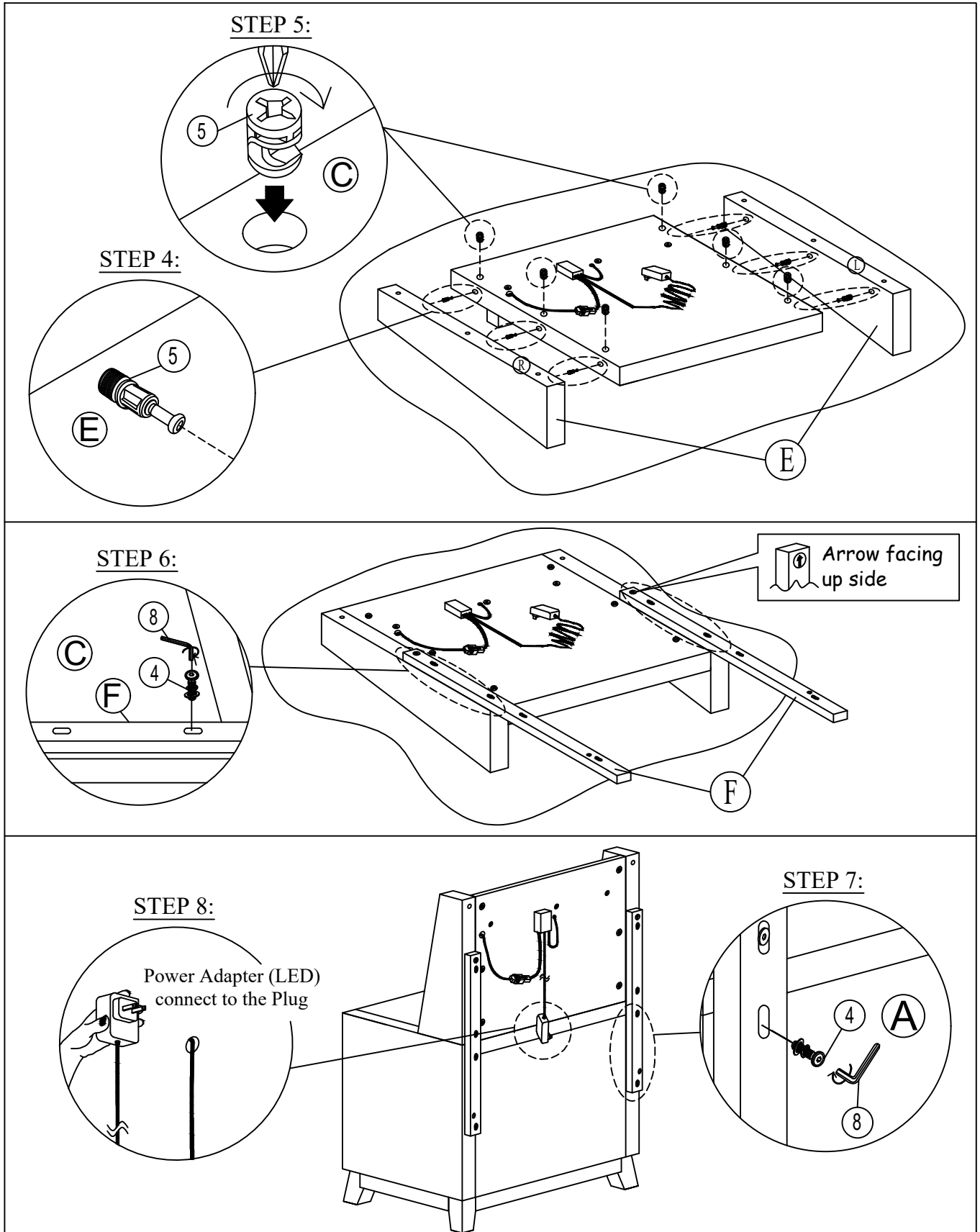

THE HARDWARE IS LOCATED IN THE PACKING ITEMS
THE ANTI TIPPING HARDWARE IS LOCATED IN THE NIGHTSTAND 1ST DRAWER

NOTE : Periodically check to ensure that all connectors (bolts, screws, etc.) are tight.

CLEANING INSTRUCTION

After assembled, clean & polish the completed parts if necessary with soft cloth and industrial recognized furniture polish

MADE IN MALAYSIA

ASSEMBLY INSTRUCTIONS

ITEM NO : B3400-2
TILSTON NIGHTSTAND W/BACK PANEL

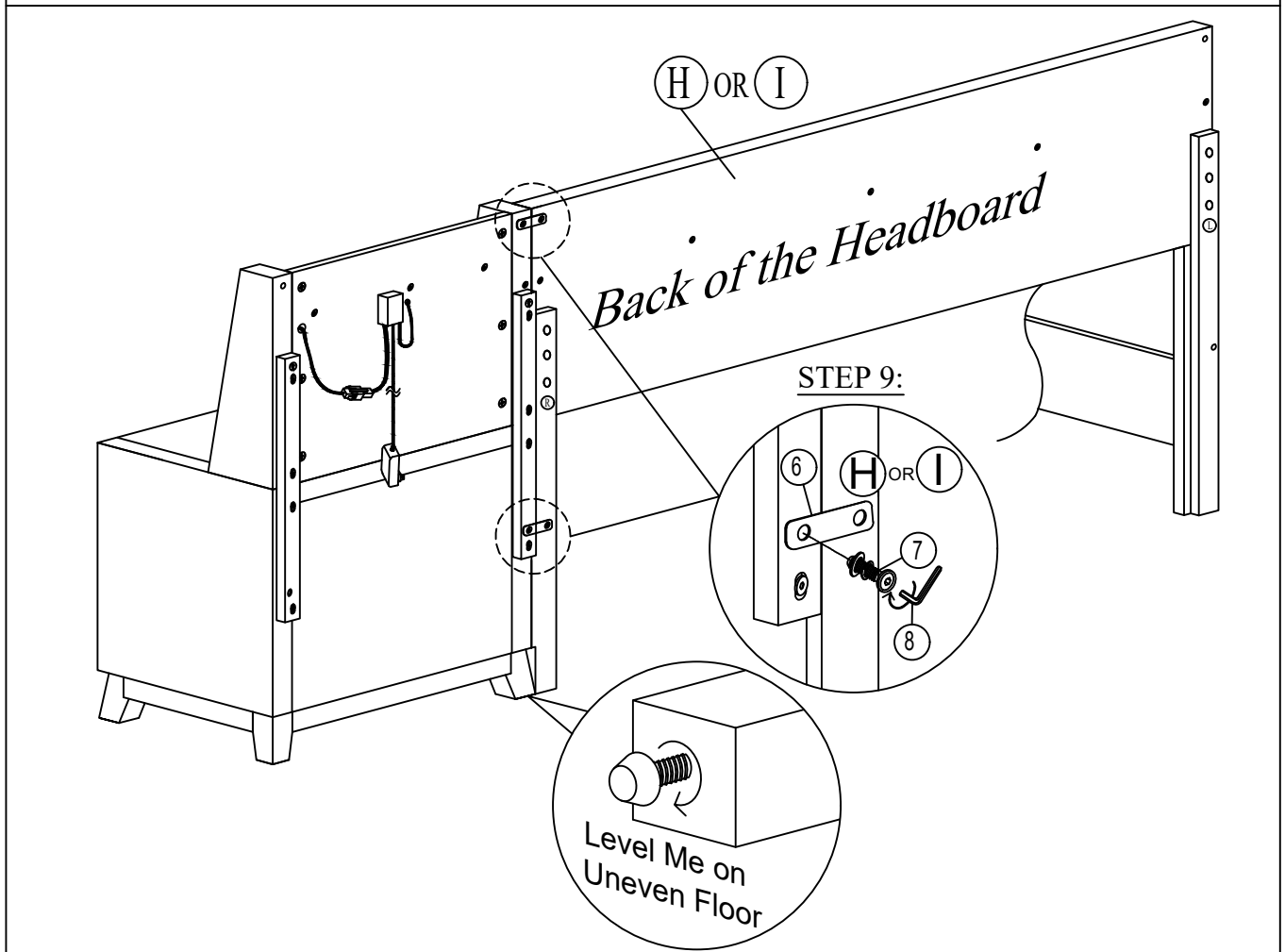
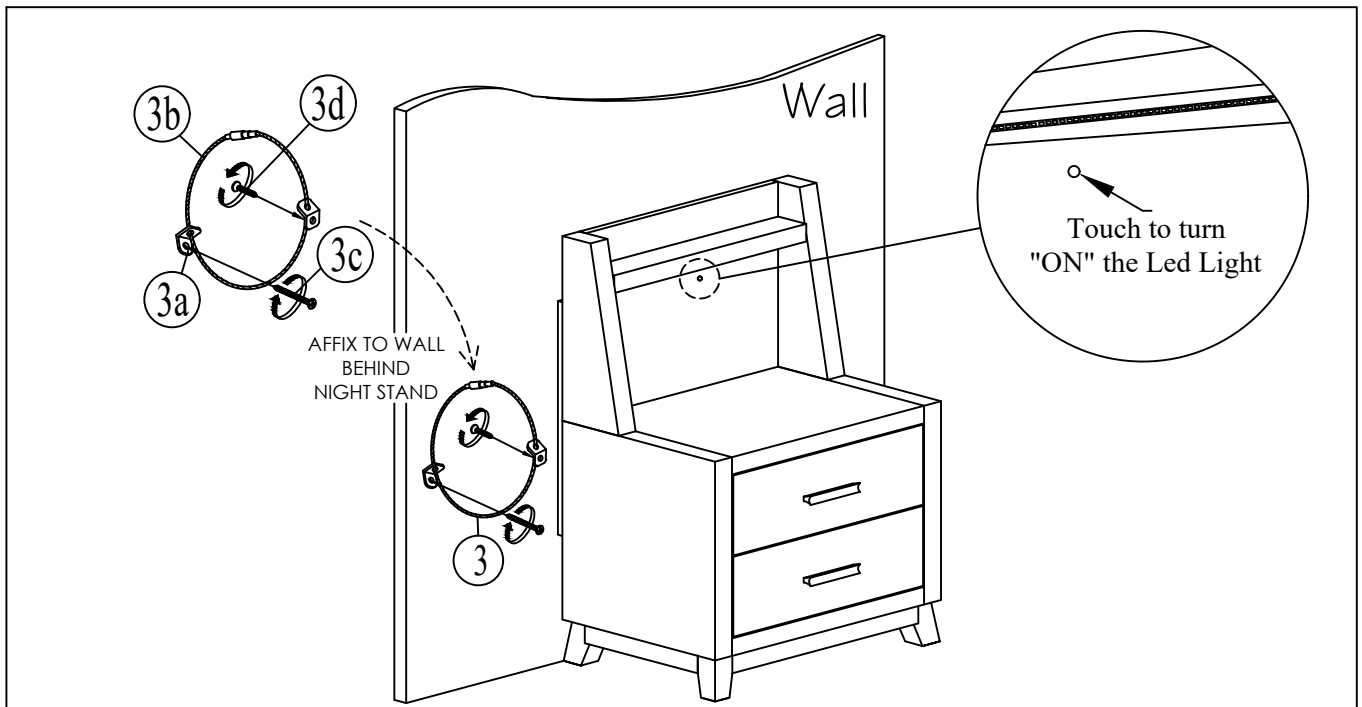

THE HARDWARE IS LOCATED IN THE PACKING ITEMS
THE ANTI TIPPING HARDWARE IS LOCATED IN THE NIGHTSTAND 1ST DRAWER

NOTE : Periodically check to ensure that all connectors (bolts, screws, etc.) are tight.

CLEANING INSTRUCTION

After assembled, clean & polish the completed parts if necessary with soft cloth and industrial recognized furniture polish

MADE IN MALAYSIA