







ASSEMBLY INSTRUCTION







MODEL NO: B3650 / B3850 / B3950 / B3750 -Q/F/T-HBFB

QUEEN/FULL/TWIN HEADBOARD/FOOTBOARD

(BOX 1)
BOX OF HEADBOARD & FOOTBOARD

ITEM	DRAWING	DESCRIPTION	Q'TY
A		HEADBOARD PANEL	1
B		LEFT HEADBOARD LEG	1
C		RIGHT HEADBOARD LEG	1
D		FOOTBOARD PANEL	1
E		LEFT FOOTBOARD LEG	1
F		RIGHT FOOTBOARD LEG	1

(BOX 1)
HARDWARE LIST BOX OF HEADBOARD & FOOTBOARD

ITEM	DRAWING	DESCRIPTION	Q'TY
1		BOLT 1/4 x 44mm	12
2		SPRING WASHER M6 x 14 mm x 2 mm	12
3		FLAT WASHER M6	12
4		WOOD DOWEL 16,3 mm x Ø x 6 mm	4
5		ALLEN KEY 58mm X 23mm X4mm E014	1
6		WOOD DOWEL Ø10,7mm x 30mm	8

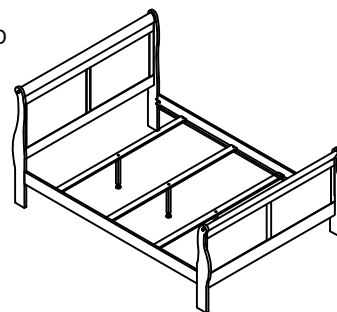

COMPLETED QUEEN/FULL/TWIN
HEADBOARD/FOOTBOARD
ASSEMBLY

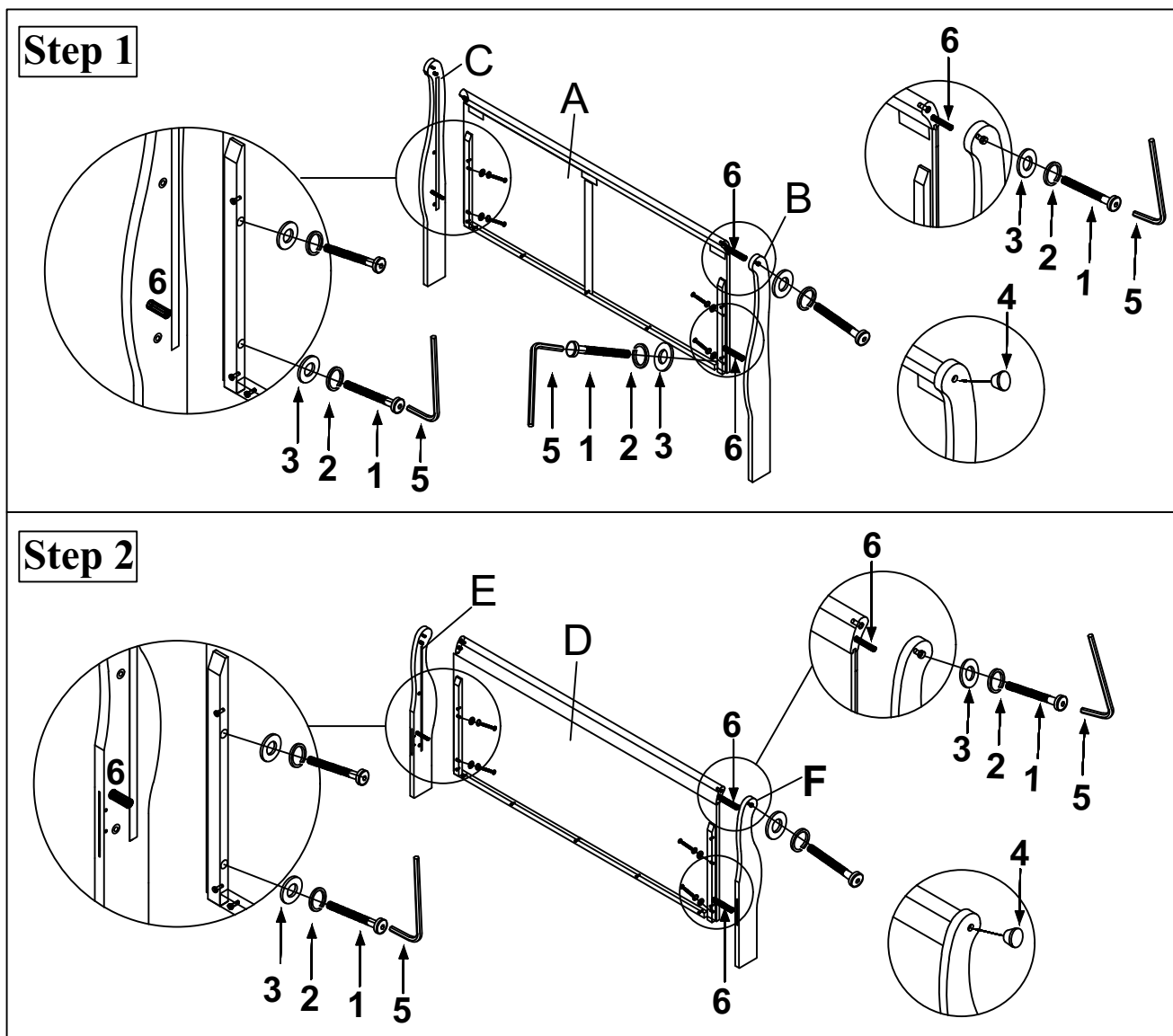

THE HARDWARE IS LOCATED IN THE PACKING ITEMS

NOTE: PERIODICALLY CHECK TO ENSURE THAT ALL CONNECTORS (BOLTS, SCREWS, ETC.) ARE TIGHT.

CLEANING INSTRUCTION



After assembled, clean & polish the completed parts if necessary with soft cloth and industrial recognized furniture polish.

MADE IN VIETNAM

ASSEMBLY INSTRUCTION

MODEL NO: B3650 / B3850 / B3950 / B3750 -Q/F/T-HBFB & -RAIL
QUEEN/ TWIN/ FULL BED

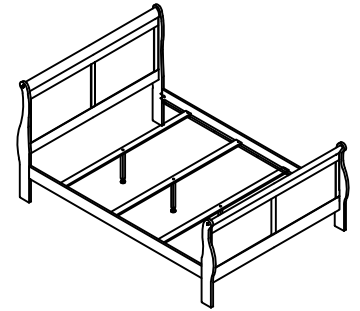

(BOX 1)
BOX OF HEADBOARD & FOOTBOARD

ITEM	DRAWING	DESCRIPTION	Qty
A		HEADBOARD	1
B		FOOTBOARD	1



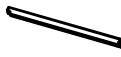

**COMPLETED QUEEN / FULL / TWIN BED
ASSEMBLY**

(BOX 2)
BOX OF SIDE RAIL

ITEM	DRAWING	DESCRIPTION	Qty
C		SIDE RAIL	2
D		WOODEN SLAT	3
E		WOODEN SUPPORT	3

(BOX 2)
HARDWARE LIST

ITEM	DRAWING	DESCRIPTION	Qty
1		CB SCREW (M4 *35mm)	6
2		SCREW DRIVER(*)	1

The manufacturer does not provide item 2.

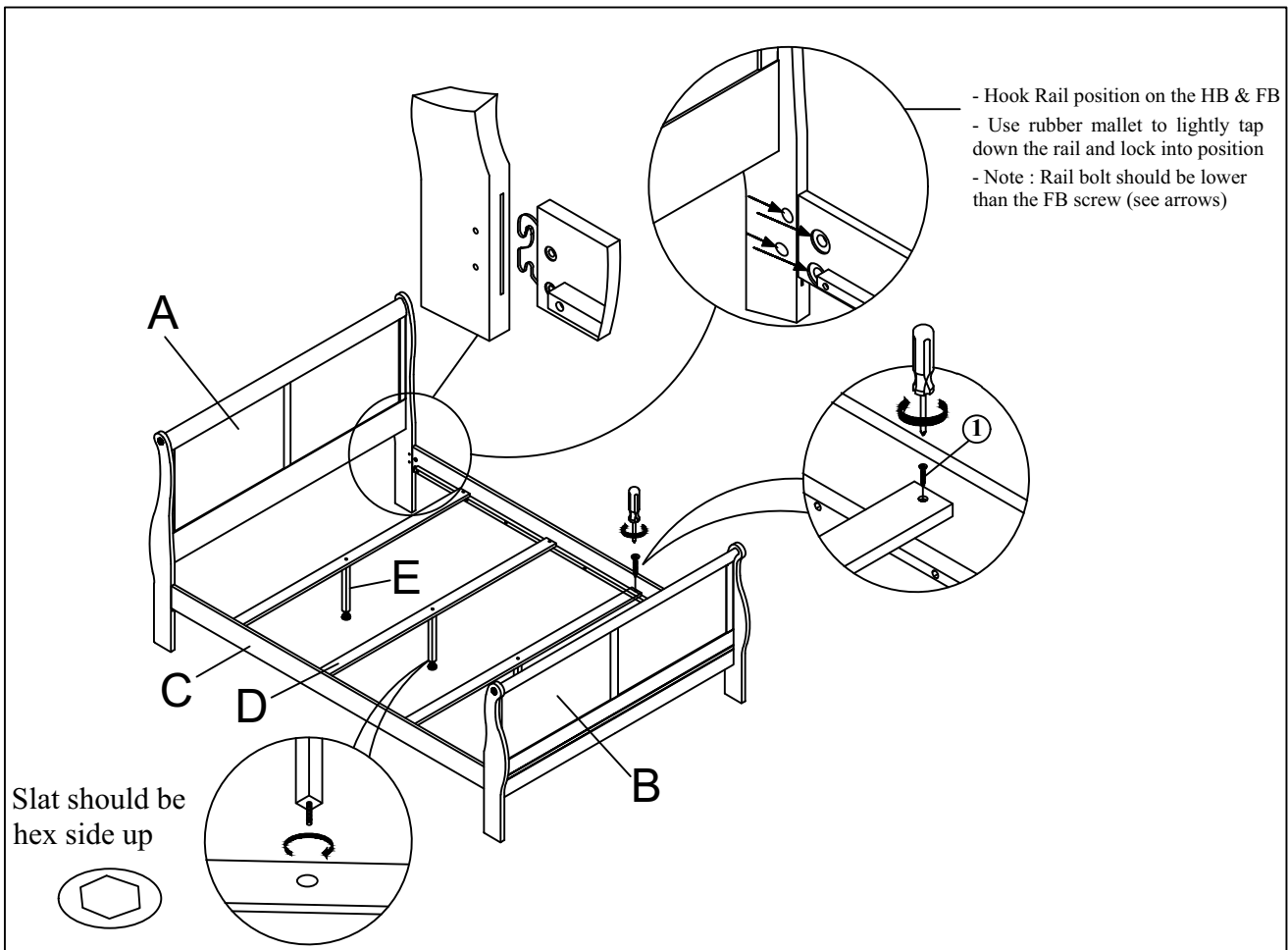

THE HARDWARE IS LOCATED THE PACKING ITEMS

NOTE: PERIODICALLY CHECK TO ENSURE THAT ALL CONNECTORS (BOLTS, SCREWS, ETC.) ARE TIGHT.

CLEANING INSTRUCTION

After assembled, clean & polish the completed parts if necessary with soft cloth and industrial recognized furniture polish.

MADE IN VIETNAM