

ASSEMBLY INSTRUCTIONS

**CROWN
B4280-1 / B4280-11
DRESSER MIRROR**

(BOX 1)
BOX OF MIRROR

NO	ITEM	QTY
A	MIRROR	1 PC
B	MIRROR SUPPORT	2 PCS

(BOX 2)
BOX OF DRESSER

NO	ITEM	QTY
C	DRESSER	1 PC

(BOX 1)
HARDWARE LIST

NO	ITEM	QTY
1	FLAT HEAD CHIPBOARD SCREW m4 x 32mm RBW	12 PCS

STEP 1 : Draw out MIRROR SUPPORT (B) from the carton box

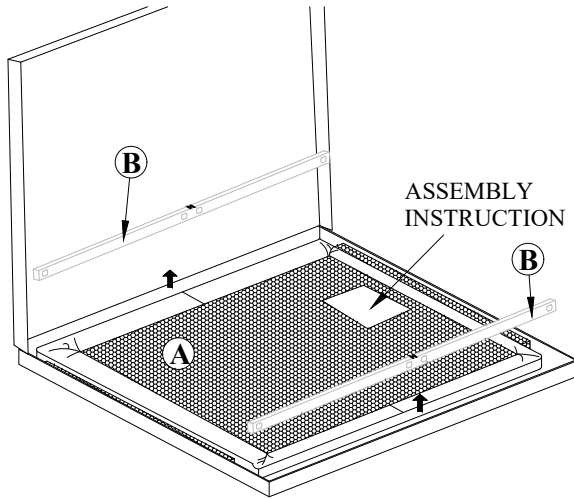

STEP 2 : Align & fasten MIRROR SUPPORT (B) to the back of MIRROR (A) using FLAT HEAD CHIPBOARD SCREW(1).

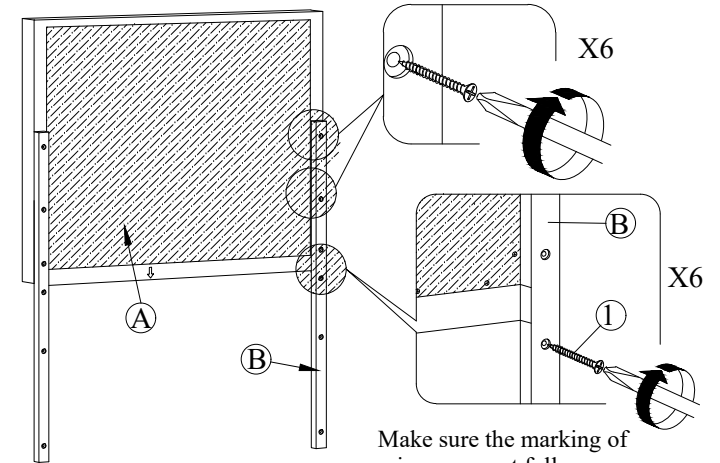

STEP 3 : Place MIRROR (A) on top of DRESSER (C). Align & fasten MIRROR SUPPORT (B) to the back of DRESSER (C). Tighten with FLAT HEAD CHIPBOARD SCREW (1)

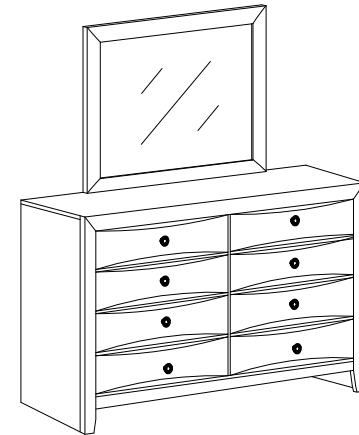
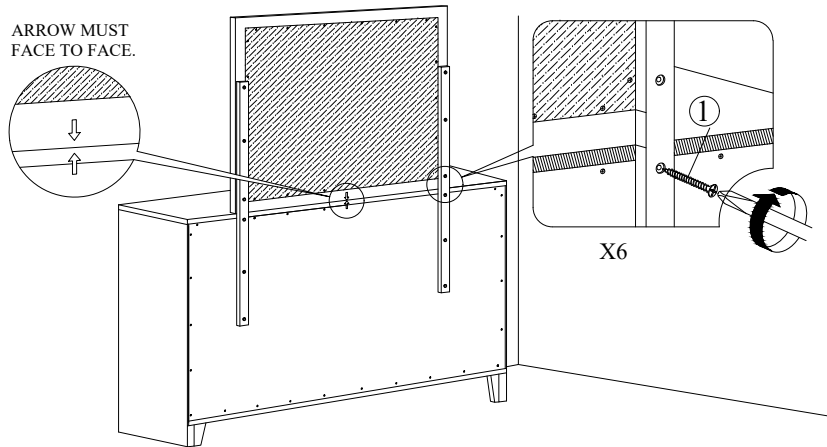

COMPLETED ASSEMBLY !!!

NOTE : MUST TIGHTEN SCREWS PERIODCALLY WITH USE SCREW WILL BECOME LOOSE CHECK TIGHTNESS OF ALL SCREW EVERY 6-8 WEEKS.