



ASSEMBLY INSTRUCTIONS

**CROWNMARK :
B4300-1/B4310-1
DRESSER**

**(BOX 1)
BOX OF DRESSER**

NO	ITEM	QTY
	DRESSER	
A		1 PC

**(BOX 1)
HARDWARE LIST**

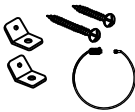
NO	ITEM	QTY
1	Truss Head Machine Screw m4x28mm Blk 	7 PCS
2	HANDLE 	7 PCS
3	Tipping Restraint 	1 PC

STEP 1 : Remove HANDLE (2) using a Philips head screw driver as shown in illustration STEP - A. Re-install the HANDLE (2) as per diagram STEP - B. Repeat STEP - A STEP - B until HANDLE (2) are attached correctly.
THE HARDWARE IS LOCATED IN THE PACKING ITEM
THE ANTI- TIPPING HARDWARE IS LOCATED IN THE TOP RIGHT DRAWER.

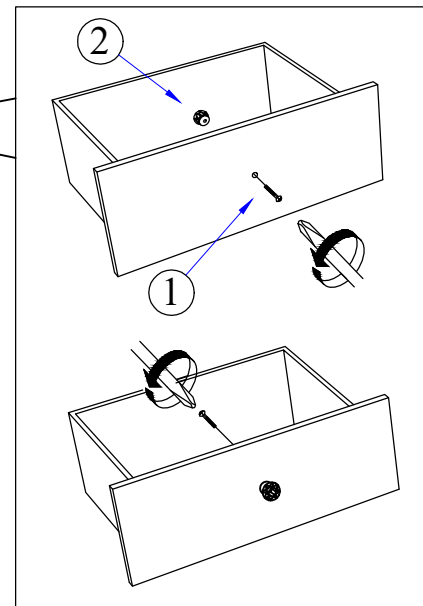
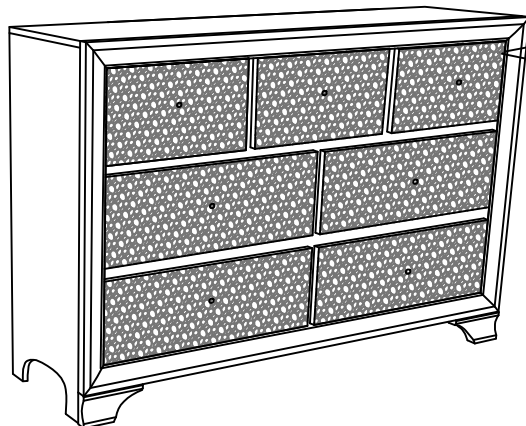

STEP - A

STEP - B

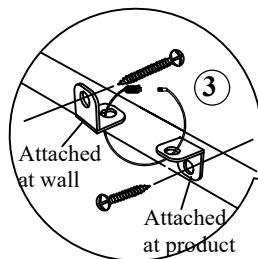

Anti - Tip Kit

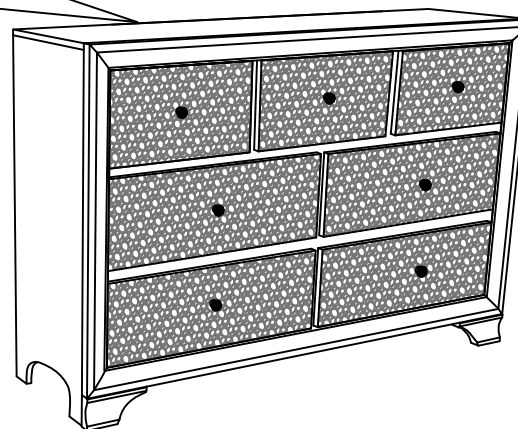

COMPLETED ASSEMBLY

NOTE : Periodically check to ensure that all connectors (bolts, screws, etc.) are tight.