

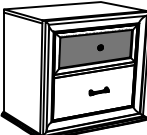

ASSEMBLY INSTRUCTIONS

CROWNMARK
MODEL :B4398-2
NIGHT STAND

(Box 1)
BOX OF NIGHT STAND

No	ITEM	Qty
A	NIGHT STAND 	1 PC
B	BUN FOOT 	4 PCS

(Box 1)
HARDWARE LIST

No	ITEM	Qty
1	Tipping Restraint 	1 PC

STEP 1 : Remove handle using a Philips head screw driver as shown in illustration STEP - A. Re-install the handle as per diagram STEP - B. Repeat STEP - A STEP - B until handle are attached correctly. THE HARDWARE IS LOCATED IN THE PACKING ITEM THE ANTI- TIPPING HARDWARE IS LOCATED IN THE TOP DRAWER.

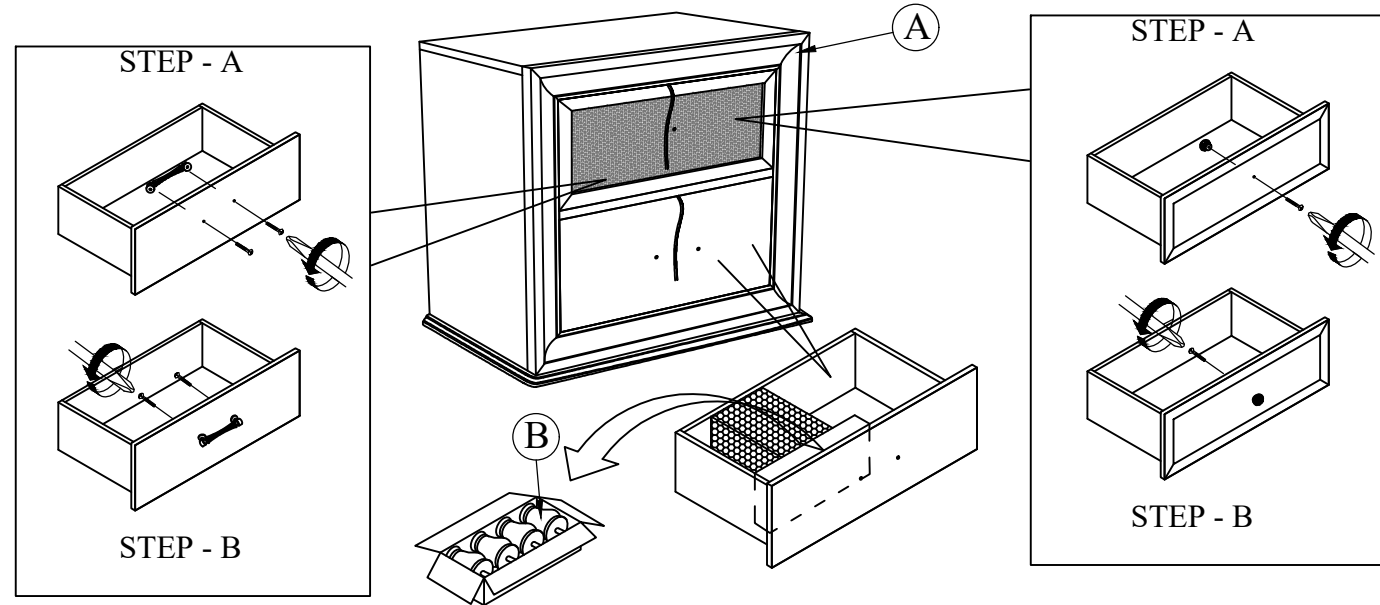

STEP 2 : Put the casegood body upright to down position on the clean surface. Turning the bun foot (B) in clockwise position for tighten.

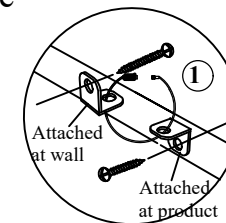
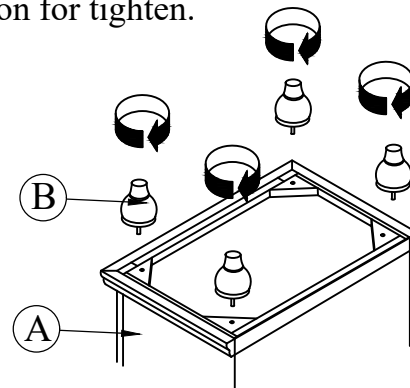

Anti - Tip Kit

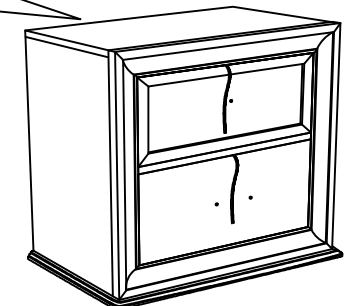

NOTE : Periodically check to ensure that all connectors (bolts, screws, etc.) are tight.