





# ASSEMBLY INSTRUCTIONS

**MODEL : B4690-1  
DRESSER**

**(BOX 1)  
BOX OF DRESSER**

NO	ITEM	QTY
A	DRESSER 	1 pc
B	BUN FOOT 	4 pcs
C	BOTTOM CENTER LEG 	1 pc

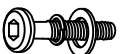
**(BOX 1)  
HARDWARE LIST**

NO	ITEM	QTY
1	JCBC Bolt m6x50mm Blk 	4 pcs
2	Allen Key m4x110mm With Ball Blk 	1 pc
3	Tipping Restraint 	1 pc

**STEP 1 :** Open the bottom drawer and take out the Bunfoot carton ( B ). Assemble the Bun Foot (B) with JCBC Bolt (1) and securing with Allen Key (2) as shown.

THE HARDWARE IS LOCATED IN THE PACKING ITEM  
THE ANTI-TIPPING HARDWARE IS LOCATED IN THE TOP  
DRAWER RIGHT.

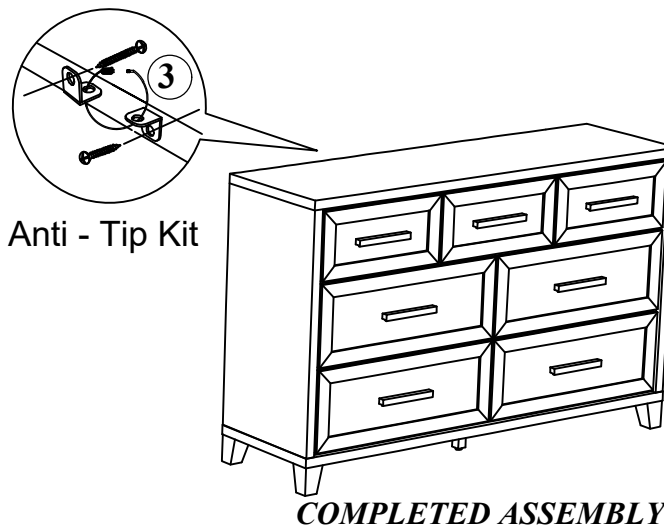
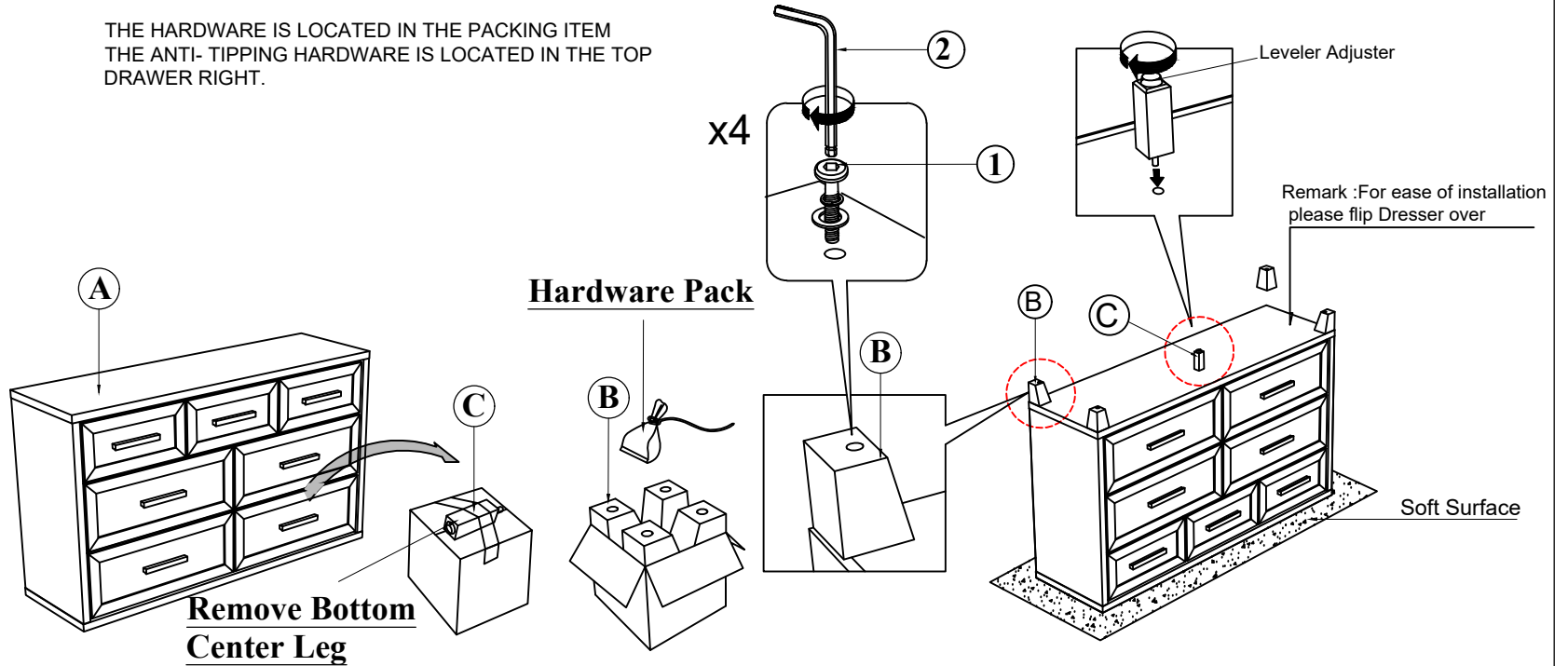

NOTE : Periodically check to ensure that all connectors (bolts, screws, etc.) are tight.