

ASSEMBLY INSTRUCTIONS



B4900-9

TV STAND

CRWN

IMPORTANT NOTE :

- * Place all wooden parts on a clean and smooth surface such as a rug or carpet to avoid the parts from being scratched.
- * Check to be sure that you have all parts and hardware.
- * Remove all wrapping materials, including staples & packing straps before you start to assemble.
- * Do not tighten all screws/bolts until all completely assembled.
- * Keep all hardware parts out of reach of children.

(BOX 1) - BOX OF TV STAND			
PARTS LIST			
NO.	DESCRIPTION	SKETCH	QTY
1	TV STAND		1
2	BUN FOOT		4
3	VERTICAL LEG		2

(BOX 1) - BOX OF TV STAND			
HARDWARE LIST			
NO.	DESCRIPTION	SKETCH	QTY
A	TIPPING RESTRAINT		1

STEP 1

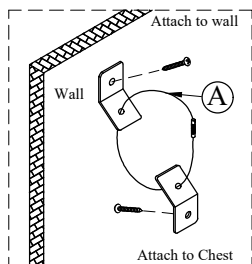
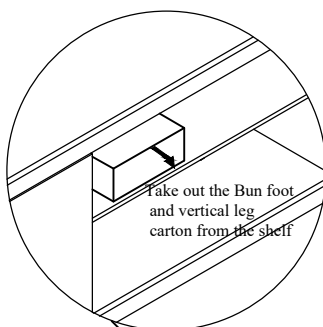

STEP 4

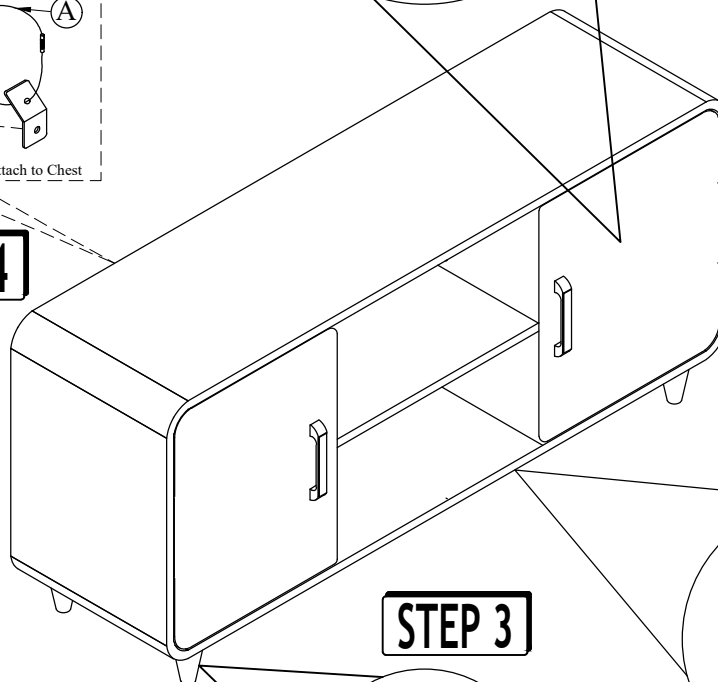

STEP 2

STEP 3

COMPLETE

PERIODICALLY CHECK TO ENSURE THAT ALL CONNECTORS(BOLTS,SCREWS,ETC.)ARE TIGHT
THE ANTI TIPPING HARDWARE IS LOCATED AT THE TOP RIGHT DRAWER OF DRESSER

THE HARDWARE IS LOCATED IN THE PACKING ITEMS