



# ASSEMBLY INSTRUCTION





ITEM NUMBER : B7200-1 & B7200-11  
 DESCRIPTION : DRESSER & MIRROR

Thank you for purchasing this quality product. Be sure to check all packing material carefully for small parts which may have loose inside the carton during shipment. Identify and count all parts and compare with the parts list below.

**(BOX 2)**  
**BOX OF MIRROR**

NO	DRAWING	DESCRIPTION	QTY
A		Mirror	1pc
B		Mirror Support	2pcs

**(BOX 2)**  
**HARDWARE LIST**

NO	DRAWING	DESCRIPTION	QTY
1		Allen key	1pc
2		JCBC 35mm	8pcs
3		M6 Spring washer	8pcs
4		1/4" Flat washer	8pcs

**(BOX 1)**  
**BOX OF DRESSER**

NO	DRAWING	DESCRIPTION	QTY
C		Dresser	1pc

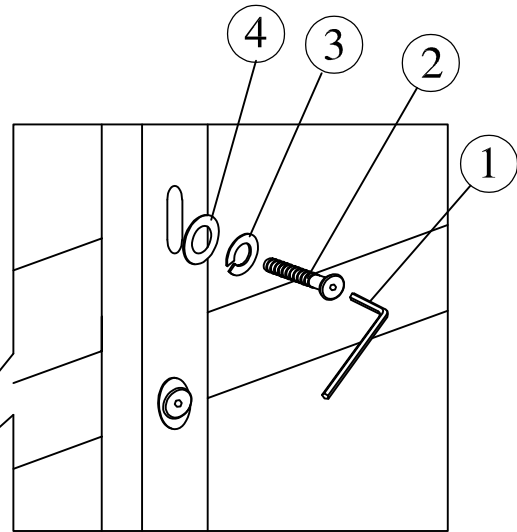
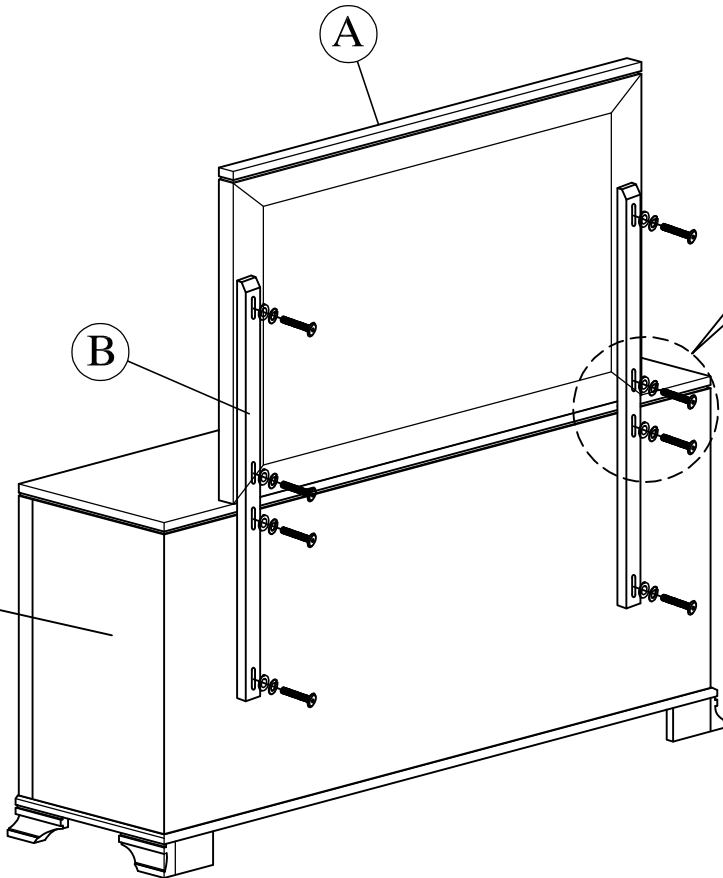

Step 1: Place (A) Mirror on the top of (C) Dresser as arrow shown. Align Mirror to the center of Dresser and tighten with (2) JCBC 35mm, (3) Spring Washer & (4) 1/4" Flat Washer.

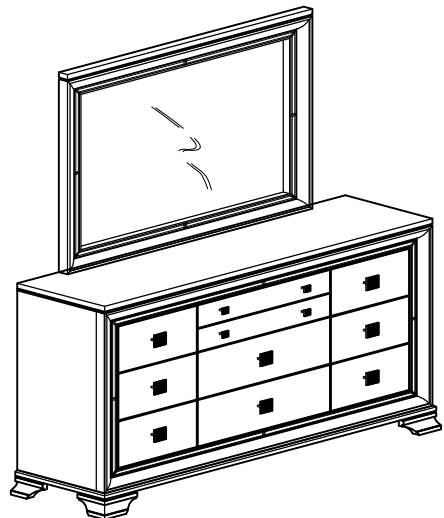

Assembly completed.

**THE HARDWARE IS LOCATED IN THE PACKING ITEM**

**THE ANTI TIPPING HARDWARE IS LOCATED IN THE RIGHT SIDE FRONT DRAWER OF DRESSER**

Note : Periodically check to ensure that all connectors (bolts,screws,etc.) are tight.

**CLEANING INSTRUCTION**

After assembly , clean & polish the completed parts if necessary with softcloth and industrial recognized furniture polish