







ASSEMBLY INSTRUCTIONS

ITEM NO : B8160 / B8162 - 1 DRESSER

BOX OF DRESSER

ITEM	DRAWING	DESCRIPTION	QTY
A		DRESSER	1

HARDWARE LIST

ITEM	DRAWING	DESCRIPTION	QTY
1		SHORT ROUND HEAD SCREW (#8 x 5/8")	1
2		LONG ROUND HEAD SCREW (#8 x 2")	1
3		CABLE TIE	1
4		L BRACKET	2
5		Assembly Tool Not Included	1

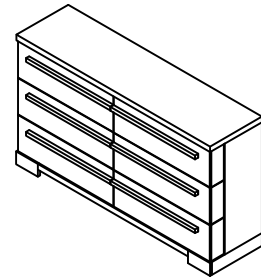

COMPLETED DRESSER ASSEMBLY

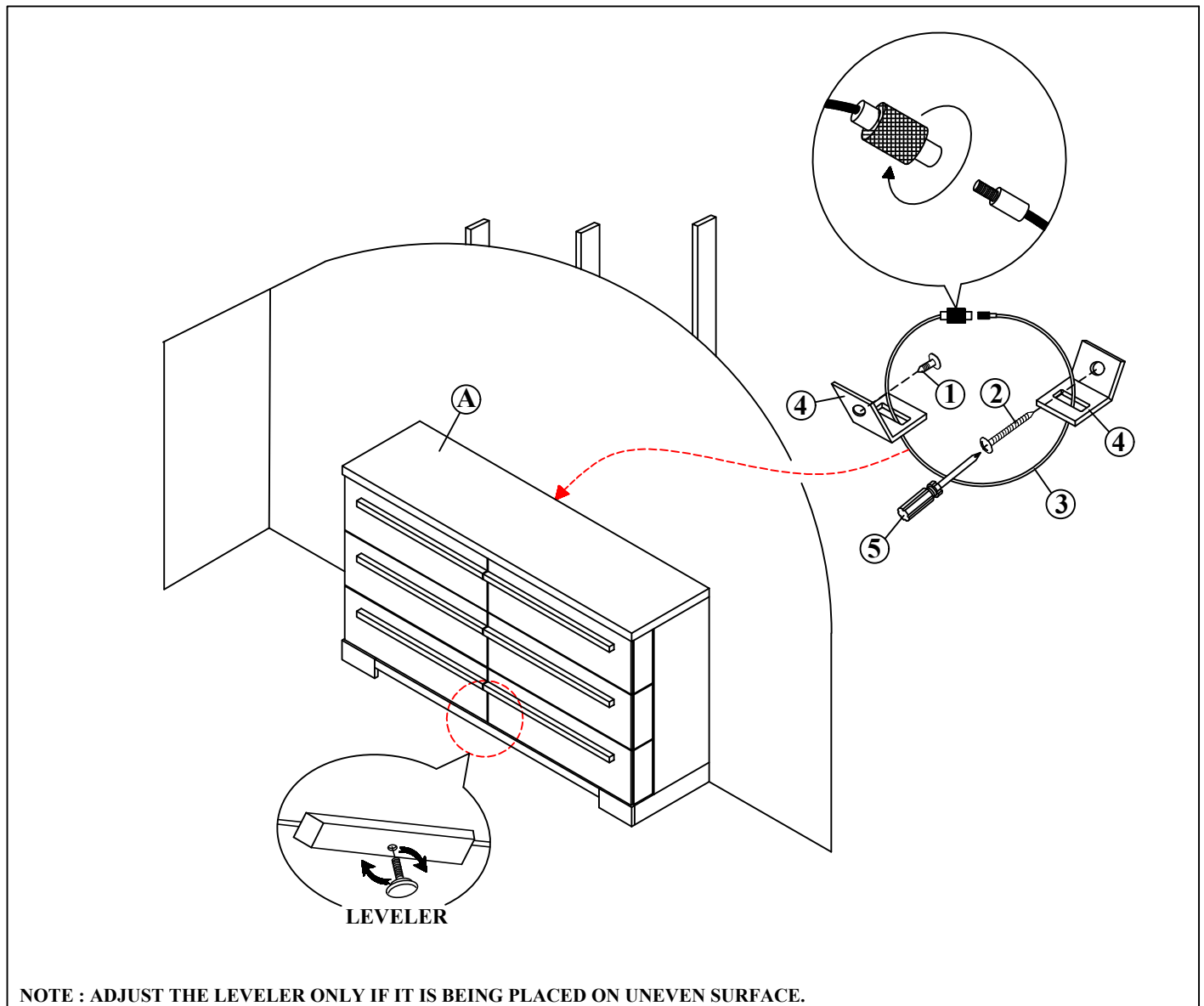

NOTE : ADJUST THE LEVELER ONLY IF IT IS BEING PLACED ON UNEVEN SURFACE.

THE ANTI TIPPING HARDWARE IS LOCATED IN THE 1ST RIGHT SIDE FRONT DRAWER OF THE DRESSER.

NOTE : Periodically check to ensure that all connectors (bolt, screws, etc.) are tight.

CLEANING INSTRUCTION

After assembly, clean & polish the completed parts if necessary with soft cloth and industrial recognized furniture polish

MADE IN MALAYSIA