



# ASSEMBLY INSTRUCTIONS

ITEM NO : B8180 - 1 & - 11 DRESSER & MIRROR



## BOX OF DRESSER

ITEM	DRAWING	DESCRIPTION	QTY
A		DRESSER	1

## BOX OF MIRROR

ITEM	DRAWING	DESCRIPTION	QTY
B		MIRROR	1
C		MIRROR SUPPORT	2

## (BOX OF MIRROR) HARDWARE LIST

ITEM	DRAWING	DESCRIPTION	QTY
1		SHORT FLAT HEAD SCREW (M4 x 32mm)	4
2		LONG FLAT HEAD SCREW (M4 x 45mm)	4
3		Assembly Tool Not Included	1

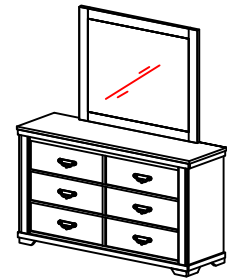

## COMPLETED DRESSER & MIRROR ASSEMBLY

## STEP 1

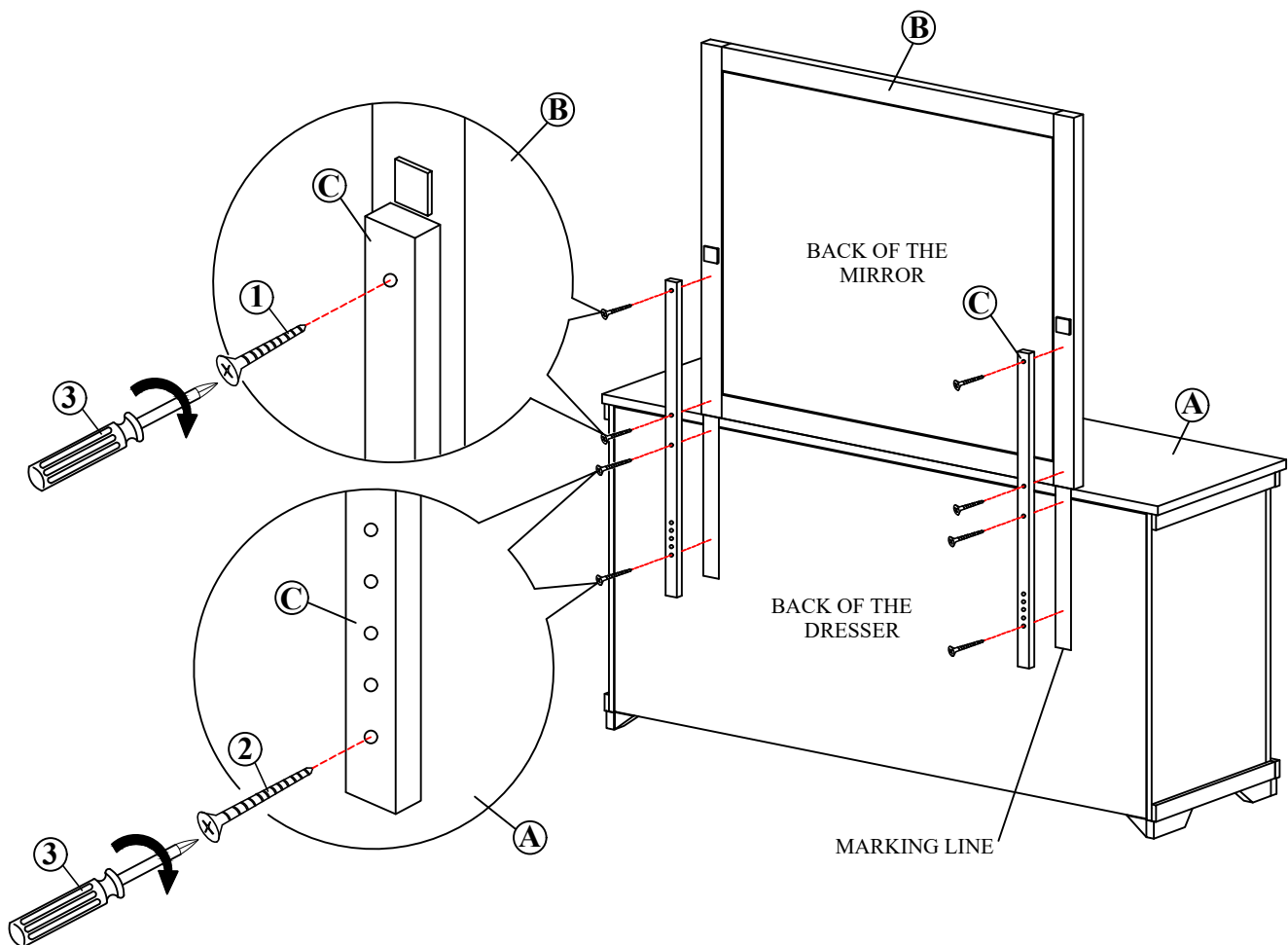

THE HARDWARE IS LOCATED IN THE PACKING ITEMS

THE ANTI TIPPING HARDWARE IS LOCATED IN THE 1ST RIGHT SIDE FRONT DRAWER OF THE DRESSER.

NOTE : Periodically check to ensure that all connectors (bolt, screws, etc.) are tight.

## CLEANING INSTRUCTION

After assembly, clean & polish the completed parts if necessary with soft cloth and industrial recognized furniture polish

MADE IN MALAYSIA